

# BW<sup>®</sup>

## TRAILER HITCHES





# DO YOU KNOW WHERE YOUR TRAILER HITCH WAS MADE? --- SHOULD YOU CARE?



You've got a lot riding on your hitch and the only thing keeping your truck and your trailer connected are those relatively small pieces of engineered steel. The hitch matters to your safety and the safety of our roads.

That's why we treat the manufacture of your trailer hitch with the respect it deserves. For one, we insist on American-made steel, like the sheet steel we buy from U.S. Steel out of Gary, Indiana or the round bar that becomes the gooseneck ball made at a mill in Norfolk, Nebraska. Where the strength and flexibility of the steel can mean life or death, we trust the U.S. steel mills with their finely controlled processes and specifications we can trust.

A hitch is only as good as the welds holding it together. We insist on making those welds under our roof. And the hard-working, skilled Americans that make the welds do so according to the American Society for Testing and Materials Welding Standard.

We wouldn't have it any other way.

A handwritten signature in black ink that reads "Joe".

- Joe Works, Owner



A man wearing a plaid shirt, a camouflage cap, and yellow gloves is kneeling in the bed of a black pickup truck. He is focused on adjusting a metal hitch component. The truck bed contains two large, brown paper-wrapped packages. The background shows a workshop or garage with various tools and equipment on shelves.

A HITCH WHEN YOU NEED IT  
**A LEVEL BED WHEN YOU DON'T**

# B&W TURNOVERBALL® GOOSENECK HITCH

CONVERTS TO A LEVEL BED IN SECONDS

Solid, One-Piece  
Machined Receiver Socket .....

Solid, Machined 2 5/16" Ball

..... Durable Powder-Coat Finish

Flexible latch pin handle attached to a spring loaded, 5/8" steel locking pin that goes completely through the ball

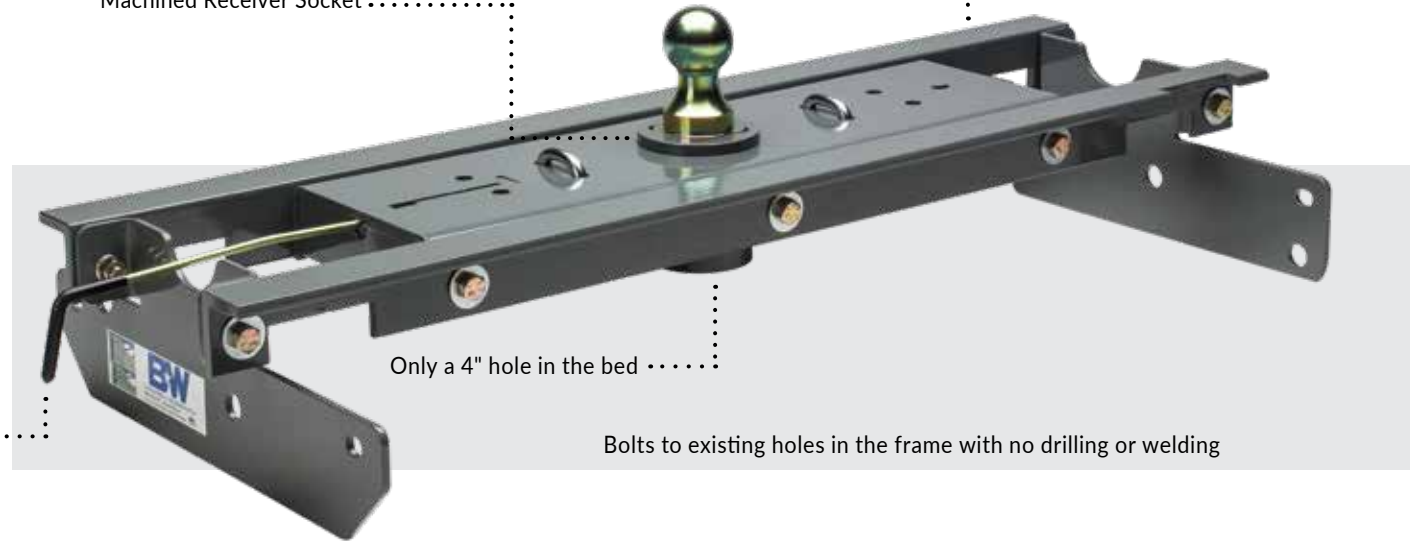

Only a 4" hole in the bed .....

Bolts to existing holes in the frame with no drilling or welding

## TURNOVERBALL® ACCESSORIES



Kingpin

4" Extender

Eyelet

Inverted Ball

Hitch Plug

3" Ball

Hi-Rise Ball  
(1" taller than standard ball)

Companion™  
5th Wheel Hitch

Companion™ Slider  
5th Wheel Hitch

20,000 LB. GTW  
5,000 LB. VTW  
DO NOT EXCEED VEHICLE TOW RATINGS

LIMITED LIFETIME WARRANTY

20,000 LB. GTW  
5,000 LB. VTW  
DO NOT EXCEED VEHICLE TOW RATINGS

LIMITED LIFETIME WARRANTY

# DEFENDER™

## LOCKING GOOSENECK COUPLER

- Integrated lock- Secures your investment with an integrated theft deterrent
- Automatic Latch- Line up the ball, drop the trailer and you're on the road!
- Heavy wall tubing- Above industry standard
- Extra holes- For increased vertical adjustment



### LARGE BULL'S-EYE

Cone shaped coupler makes lining up easier

25,000 LB. GTW  
7,500 LB. VTW

DO NOT EXCEED VEHICLE TOW RATINGS

LIMITED LIFETIME WARRANTY

# OEM BALL & SAFETY CHAIN KIT

- Handle provides leverage for operation and a clean way to carry the ball
- Handle locks in horizontal position to prevent accidental unlatching
- Internal and external components are plated or made from stainless steel for corrosion protection
- Safety chain anchors accommodate commercially available safety chain hooks

30,000 LB. GTW  
7,500 LB. VTW  
DO NOT EXCEED VEHICLE TOW RATINGS

LIMITED LIFETIME WARRANTY

## RUBBER PLUG

covers hole when not towing



# **B&W™ GOOSENECK SHORT-BED SOLUTIONS**

MORE TURNING CLEARANCE FOR YOUR SHORT-BED TRUCK

**\* WARNING:**

Turning clearance problems may be encountered when towing gooseneck trailers with short-bed models.





## 4" EXTENDER OFFSETS BALL 4"

- An accessory to the Turnoverball®
- Moves pivot point rearward four inches
- Removable
- Made from 3/4" steel plate

20,000 LB. GTW  
5,000 LB. VTW  
DO NOT EXCEED VEHICLE TOW RATINGS

LIMITED LIFETIME WARRANTY



## EXTEND-A-GOOSE OFFSETS BALL 10"

- Self-aligning coupler design
- Heavy wall tube with internal gussets provides maximum strength
- Easier hook ups with more clearance at the tailgate and trailer
- Fits all standard 4" I.D. round trailer tubes
- Funnel shaped coupler assists in aligning the trailer with the hitch.
- Accommodates padlock for theft prevention

24,000 LB. GTW  
6,000 LB. VTW  
DO NOT EXCEED VEHICLE TOW RATINGS

LIMITED LIFETIME WARRANTY



+4"

+10"

4"

10"

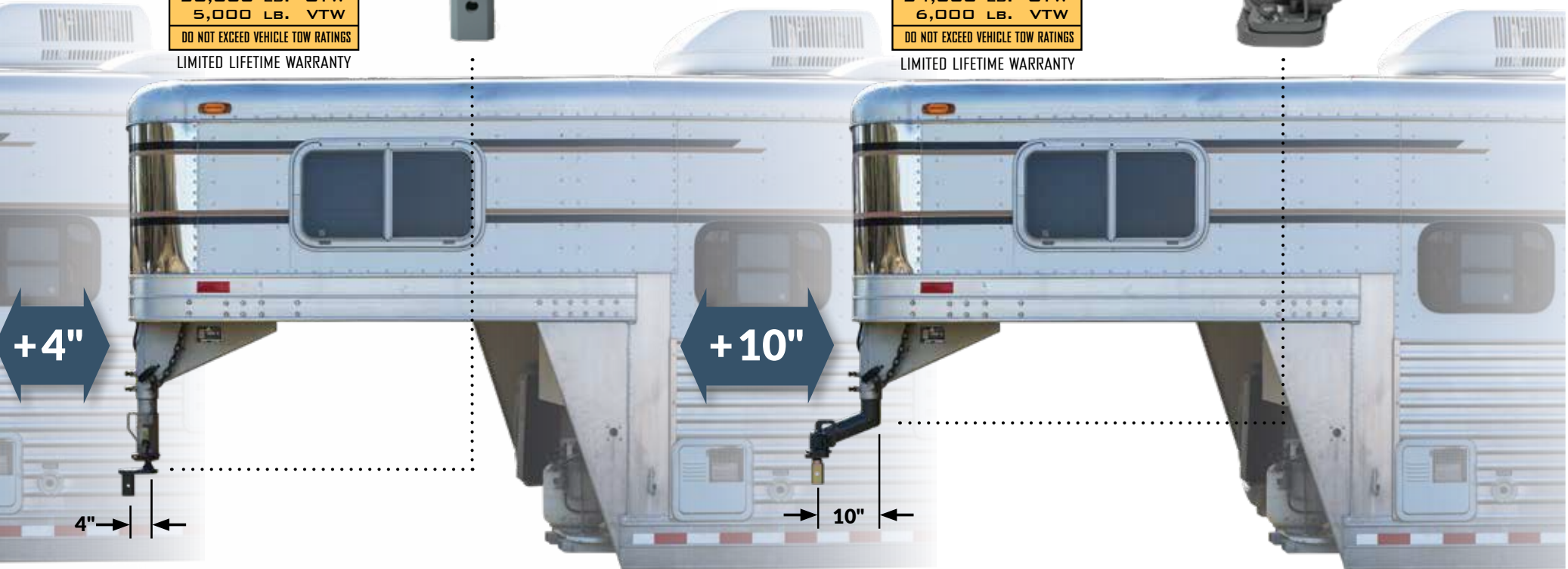





# A HITCH FOR EVERY TRUCK

With so many fifth-wheel hitches being offered, making a choice can be tough. We're here to help. One of the first questions to ask yourself: "How would I like my trailer hitch to attach to my truck?"

## NO RAILS

When we invented the Turnoverball Gooseneck Hitch over 25 years ago, customers loved being able to turn the ball over and have their truck bed free. A few years later, we started asking ourselves if that could be done with a fifth-wheel hitch. It turns out, the answer is 'yes!' Our Companion Fifth-Wheel Hitch uses the same under-bed mounting system as the original Turnoverball and has a single-point attachment. When you're not using it, the Companion is removable and your truck is free to haul something else.

## PUCKS

A few years ago, some truck manufacturers started offering a mounting system for fifth-wheels as a factory option in new trucks. These mounting systems use 'pucks', arranged at different spacing as a means for attachment. We build Companion Bases that work with these pucks at the four corners.

## RAILS

While permanent rails in a truck aren't for everybody, they are still a preferred method of attachment for some. Our Patriot line was born when customers asked us to take the lovable features of the Companion, but mount them on industry standard rails. So, we did. The Patriot, like all of our products, is made in America.

# B&W COMPANION™

---

## INSTALLS AND REMOVES EASILY



**NO RAILS**



### AVAILABLE MODELS:

- COMPANION
- COMPANION SLIDER
- COMPANION FLATBED

Utilizes the B&W Turnoverball under-bed mounting system.

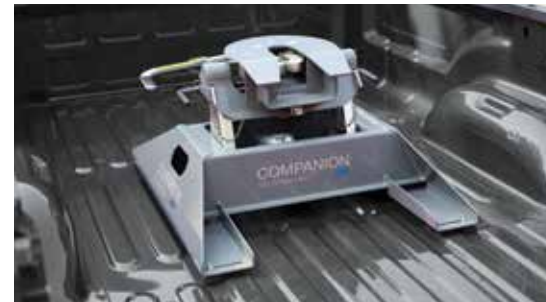

**1. Companion™ Installed**



**2. Remove Coupler**



**3. Remove Base**



**4. Use your truck bed for something else**



# PUCKS



## AVAILABLE MODELS:

- COMPANION FOR FORD PUCKS
- COMPANION FOR RAM PUCKS
- COMPANION FOR GM PUCKS

..... Designed to work with the Ram factory hitch platform.



# RAILS



## AVAILABLE MODELS:

- PATRIOT 18K SLIDER
- PATRIOT 18K™
- PATRIOT 16K™

Fits all Standard Mounting Rails

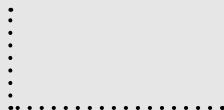

# TOWING WITH A SHORT-BED TRUCK

---

Another important consideration when deciding on a fifth-wheel hitch is this: SLIDER OR NO SLIDER?

A sliding hitch allows you to move the pivot point of the hitch rearward when maneuvering so that your trailer nose doesn't hit the cab of your truck. There are several schools of thought on this question, but it really comes down to personal preference.

If you have a short-bed truck and you anticipate doing a lot of tight turns and maneuvering into campgrounds, you should consider a slider.

On the other hand, we sold thousands of hitches that were stationary before we built our first slider. Many RV owners have opted to just 'watch carefully' when making tight turns.

Slider or no Slider, it's important to know how much turning clearance you have. See our video on how to measure this distance on our website.



**NO RAILS**



Companion Slider



**NEED ROOM TO MANEUVER?  
OF COURSE YOU DO!**

**PUCKS**

**RAILS**



Tight tolerances in the sliding mechanism means smooth movement without the rattle.



..... RAM OEM Slider



..... Patriot Slider

# THE B&W™ DIFFERENCE

A LINE OF FIFTH-WHEEL HITCHES BASED ON A SINGLE GOAL:  
**CREATE A SMOOTH, WORRY-FREE RIDE.**

## JAWS

Wrap-around jaws fit your kingpin perfectly, eliminating sloppy starts and stops. Our tolerances are +/- .002 inch, about the thickness of a piece of paper.

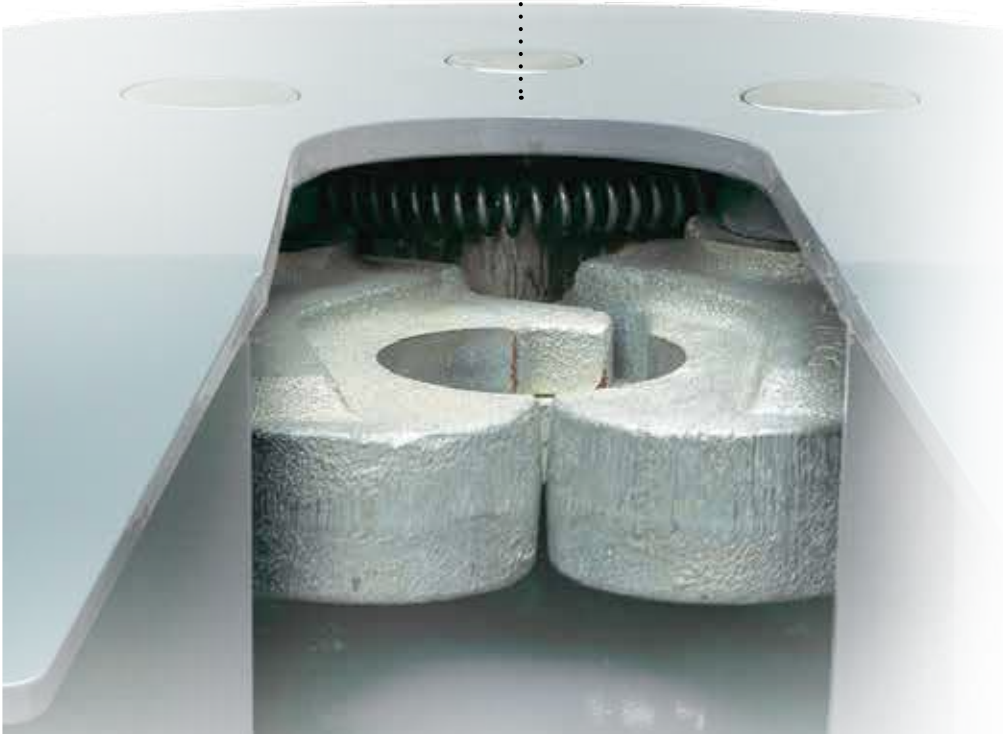

## CAM-ACTION HANDLE

Open the cam-action handle and our jaws release—every time. Even when parked on unlevel sites.







## POLYURETHANE BUSHINGS

The entire coupler rides on polyurethane bushings to provide a quiet, rattle-free towing experience.



# WHICH HITCH IS RIGHT FOR YOU?

## NO RAILS



The **Companion™**, adored by RVers, was designed to address the issue of sloppiness in hitches. The result is a smooth, quiet, cushioned ride. And it's removable so you can free up your truck bed when you aren't towing.

### GTW 20,000 LBS. - VTW 5,000 LBS.

Utilizes B&W's under-bed mounting system, that also accommodates a gooseneck ball

1" thick cast, wrap-around jaws

Cam-action handle works even in a bind.

Polyurethane bushings for a smooth ride

Height adjustment 16<sup>1/4"</sup>, 17<sup>1/4"</sup>, 18<sup>1/4"</sup>

Side-to-side dampening

**LIMITED LIFETIME WARRANTY**

## NO RAILS



The **Companion Slider** has all the benefits that customers love about our Companion, but adds the additional turning clearance you might need with a short-bed truck. It has an automatic latch in both directions, 12 inches of rearward travel and it's removable.

### GTW 20,000 LBS. - VTW 5,000 LBS.

Utilizes B&W's under-bed mounting system, that also accommodates a gooseneck ball

1" thick cast, wrap-around jaws

Cam-action handle works even in a bind

Polyurethane bushings for a smooth ride

Height adjustment 17", 18", 19"

Side-to-side dampening

**LIMITED LIFETIME WARRANTY**

## NO RAILS



The **Companion Flatbed**. It's the Companion only smaller. The same coupler used on the Companion is attached to a low-profile base. It's designed to be used with steel flatbeds.

### GTW 22,000 LBS. - VTW 5,500 LBS.

Utilizes B&W's flatbed mounting system GNRK1500

1" thick cast, wrap-around jaws

Cam-action handle works even in a bind

Polyurethane bushings for a smooth ride

No adjustment

Side-to-side dampening

**LIMITED LIFETIME WARRANTY**

## PUCKS



\*Companion for Ram Pucks shown.

The **Companion for Ford, GM and Ram Pucks** have all the things that you love about the Companion, but it's designed to work with the factory hitch platform. Instead of the single-point attachment with the traditional Companion, it utilizes the factory four-puck system.

### FORD & GM: GTW 20,000 LBS. - VTW 5,000 LBS.

RAM: GTW 25,000 LBS. - VTW 6,250 LBS.

Utilizes the factory installed hitch platform

1" thick cast, wrap-around jaws

Cam-action handle works even in a bind

Polyurethane bushings for a smooth ride

FORD & GMC: Height adjustment 16.75", 17.75", 18.75"  
RAM: Height adjustment 17", 18", 19"

Side-to-side dampening

**LIMITED LIFETIME WARRANTY**

The hitch may be small, but don't underestimate its importance. This engineered metal can make the difference between a comfortable ride and a nail-biter. We developed a line of fifth-wheel hitches based on a single goal: create a smooth, worry-free ride.

## PUCKS



The **Companion Slider for Ford, GM and Ram Pucks** have all the things that you love about the Companion, but it's designed to work with the factory hitch platform. Instead of the single-point attachment with the traditional Companion, it utilizes the factory four-puck system.

**GTW 20,000 LBS. - VTW 5,000 LBS.**

Utilizes the factory installed hitch platform

1" thick cast, wrap-around jaws

Cam-action handle works even in a bind

Polyurethane bushings for a smooth ride

FORD & GMC: Height adjustment 16.75", 17.75", 18.75"  
RAM: Height adjustment 17", 18", 19"

Side-to-side dampening

**LIMITED LIFETIME WARRANTY**

## RAILS



The **Patriot 18K Slider** is our rail mounted hitch now available with 12 inches of slide for maneuvering a short-bed truck.

**GTW 18,000 LBS. - VTW 4,500 LBS.**

Utilizes standard rails including B&W's RVR3200

3/4" thick cast, wrap-around jaws

Automatic latching in both directions of slide

Sturdy center support of rails means no binding during sliding

Polyurethane bushings for a smooth ride

Height adjustment 17", 18", 19"

**LIMITED LIFETIME WARRANTY**

## RAILS



The **Patriot 18K™** is our answer to the rail mounted imports offered by our competitors. Designed as a less-expensive, lighter-weight alternative to its big brother, the Companion, with many of the same great features.

**GTW 18,000 LBS. - VTW 4,500 LBS.**

Utilizes standard rails including B&W's RVR3200

3/4" thick cast, wrap-around jaws

Cam-action handle works even in a bind

Polyurethane bushings for a smooth ride

Height adjustment 16", 17", 18", 19"

Side-to-side pivot with spring cushioning

**LIMITED LIFETIME WARRANTY**

## RAILS



The **Patriot 16K™** is our rail mounted hitch. It's a less-expensive, lighter weight version of the Companion.

**GTW 16,000 LBS. - VTW 4,000 LBS.**

Utilizes standard rails including B&W's RVR3200

3/4" thick cast, wrap-around jaws.

Cam-action handle works even in a bind.

Polyurethane bushings for a smooth ride.

Height adjustment 16", 17", 18", 19"

Side-to-side pivot with spring cushioning

**LIMITED LIFETIME WARRANTY**

# B&W TOW & STOW®

STOWS UNDER THE VEHICLE WHEN NOT IN USE



Fits any standard 2", 2 1/2" or 3" receiver

Easily locked into the receiver tube to prevent theft

Stainless steel pins

Multiple ball sizes eliminate the need for multiple ball mounts

Two process plating to help prevent corrosion

Now with a two-step finish: ecoat and powder coat, which provides improved corrosion protection inside and out (Also available in chrome)

CLASS IV	10,000 LB. GTW
	1,000 LB. VTW
DO NOT EXCEED VEHICLE TOW RATINGS	

2" Shank  
LIMITED LIFETIME WARRANTY

CLASS IV	14,500 LB. GTW
	1,450 LB. VTW
DO NOT EXCEED VEHICLE TOW RATINGS	

2 1/2" Shank  
LIMITED LIFETIME WARRANTY

CLASS IV	21,000 LB. GTW
	2,100 LB. VTW
DO NOT EXCEED VEHICLE TOW RATINGS	

3" Shank  
LIMITED LIFETIME WARRANTY

## Rotate the Ball

To the Desired Size



## Adjust the Height

Raise or Lower



## Stow the Hitch

Under the Vehicle





---

**TIRED OF  
SWITCHING  
BALL MOUNTS?**

---



**THE LAST HITCH  
YOU'LL EVER NEED**

# B&W TOW & STOW<sup>®</sup>

STOWS UNDER THE VEHICLE WHEN NOT IN USE

## AVAILABLE ADJUSTMENTS

**Model 12**  
9" Drop  
9-1/2" Rise

**Model 10\***  
7" Drop  
7-1/2" Rise

**Model 8\***  
5" Drop  
5-1/2" Rise

**Model 6**  
3" Drop  
3-1/2" Rise



## TOW & STOW WITH DROP DOWN PINTLE

**Pintle Up**  
Ready to hook on.



## AVAILABLE BALL COMBINATIONS

**Dual-ball Combination**

2-5/16"



2"

**Dual-ball Combination**

2"



1-7/8"

**Tri-ball Combination**

1-7/8"



2-5/16"

2"

**Pintle Down**  
Ready to tow.



## AVAILABLE FINISHES



Licensed Browning Logo



Black Powder Coat



Chrome

**Stowed**  
Ready to go.



# B&W™ 16K HEAVY-DUTY RECEIVER HITCH



- Three Piece Interlocking Design
- Six Point Frame Mount
- Grade 8 Mounting Hardware
- Boxed for Product Protection and Easier Shipping



CLASS	16,000 LB. GTW
	1,600 LB. VTW
DO NOT EXCEED VEHICLE TOW RATINGS	

LIMITED LIFETIME WARRANTY



# B&W™ AMERICAN MADE

## HEAVY-DUTY TOWING ACCESSORIES



### HEAVY-DUTY BALL MOUNTS HIGH GLOSS POWDER COAT FINISH

Part #	Drop	Shank
BMHD30010	2" Drop	2" x 6" Shank
BMHD30011	2" Drop	2" x 8" Shank
BMHD30012	4" Drop	2" x 6" Shank
BMHD30013	4" Drop	2" x 8" Shank
BMHD30014	6" Drop	2" x 6" Shank
BMHD30210	2" Drop	2.5" x 6" Shank
BMHD30212	4" Drop	2.5" x 8" Shank
BMHD30214	6" Drop	2.5" x 6" Shank

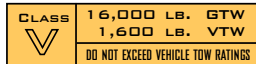

LIMITED LIFETIME WARRANTY



### HEAVY-DUTY PINTLE PLATE HIGH GLOSS POWDER COAT FINISH

Part #	Hole	Position	Shank
PMHD14001	6 Hole,	2 Position,	2" x 9" Shank
PMHD14002	8 Hole,	3 Position,	2" x 9" Shank
PMHD14003	8 Hole,	3 Position,	2" x 11" Shank
PMHD14004	14 Hole,	6 Position,	2" x 13" Shank
PMHD14005	14 Hole,	6 Position,	2" x 15" Shank
PMHD14202	8 Hole,	3 Position,	2.5" x 9" Shank

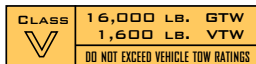

LIMITED LIFETIME WARRANTY

### HITCH BALLS SPECIALTY AND HEAT TREATED



Part #	Ball Diameter	Shank Diameter	Shank Length	Max Load	Rise	Threads Per Inch	Finish
HB94001	2-5/16"	1"	2-1/2"	12K	No Rise	14	Heat Treated
HB94002	2-5/16"	1-1/4"	2-1/2"	24K	1"	12	Heat Treated
HB94003	2-5/16"	1-1/4"	3-1/4"	24K	1"	12	Heat Treated
HB94004	2-5/16"	1-1/4"	2-1/2"	30K	No Rise	12	Heat Treated
HB94005	2-5/16"	1-1/2"	2-3/4"	30K	1"	12	Heat Treated
HB94006	2-5/16"	1-1/2"	2-3/4"	30K	2"	12	Heat Treated
HB94007	2-5/16"	1-3/8"	2-3/4"	30K	1"	12	Heat Treated
HB94008	3"	2"	3-1/4"	30K	No Rise	12	Heat Treated
HB94009	2-5/16"	2"	3-1/2"	30K	No Rise	4.5	Heat Treated
HB94011	2-5/16"	2-3/16"	4"	30K	No Rise	n/a	Heat Treated
HB94012	Ball Collar	2.199 ID	2" Tall				Untreated
HB94013	Ball Collar	2.199 ID	3" Tall				Untreated
HB94050	2-5/16"	1-1/4"	2-1/2"	16K	No Rise	12	Chrome

### TRIPLE TOW BALL MOUNT HIGH GLOSS POWDER COAT FINISH

BMTT31004 Triple Tow Ball Mount



LIMITED LIFETIME WARRANTY





# B&W™ CAB PROTECTOR

BUILT TO PROTECT.  
DESIGNED TO FIT.

The cab protector and a glass window is all that stands between you and that heavy load of equipment in the bed of your truck. That's why B&W makes sure it's strong enough to protect your cab. But we couldn't overlook the way it makes the truck look. That's why it's designed to fit.





# IT'S OUR POLICY TO STAND BEHIND OUR PRODUCTS

**We are confident that our products are made without design or quality defects.** However, if you believe that one of our products doesn't live up to our standards, we would make it right with you, our customer.

If your product suffers damage because of an accident or misuse on your part, we would work with you to get you back on the road with as little cost and hassle to you as possible, because that is just being a good neighbor.

We can't keep your product in 'new' condition and your product and the finish will age through normal wear and tear. You should only use our products in the manner intended in their design. Most of our products require some minimal maintenance to continue to work as they did when they were new.

We appreciate it when our customers register their products with us. However, we offer our warranty regardless.

To register your product or download a copy of our limited lifetime warranty call us at **800-248-6564** or visit **[www.bwtrailerhitches.com/warranty](http://www.bwtrailerhitches.com/warranty)**.



**BW**  
**TRAILER HITCHES**

**B&W Trailer Hitches**  
**1216 Hawaii Road**  
**Humboldt, KS 66748**  
**800-248-6564**

[www.bwtrailerhitches.com](http://www.bwtrailerhitches.com)